

Level sensing relative and absolute pressure transmitter type 713

Pressure range
0 ... 0.6 - 16 bar



The pressure level transmitter type 713 is used for continuous fluid level measurement of ground and drinking water. The compact design allows the transmitter to be used in applications with restricted access as small as $\frac{3}{4}$ inch i.d. pipe.

As well as a current output the pressure level transmitter type 713 has been enhanced with energy efficient ratiometric and digital outputs making it ideal for battery powered applications.

The pressure level sensor 713 is based upon the well proven ceramic technology developed by Huba Control over 20 years ago.

- Ceramic sensor Al_2O_3 99.6%
- Continuous level measurement
- Suitable for drinking water
- Available with integrated temperature measurement
- Applicable in $\frac{3}{4}$ inch pipes
- Excellent linearity and long term stability

Technical overview

Pressure range

Relative	0 ... 0.6 - 16 bar
Absolute	0.8 ... 1.4 - 3 bar

Operating conditions

Medium	Groundwater Drinking water (with EPDM O-ring)
Temperature	Medium and ambient ¹⁾ Storage -20 ... +80 °C -40 ... +80 °C
Overload	acc. order code selection table

Materials in contact with medium

Case	Stainless steel 1.4404 / AISI 316L
Sensor	Ceramic Al ₂ O ₃ (99.6%)
Cable	PE-HD
Protection cover	PPE
Sealing material	FPM, EPDM (for drinking water)

Electrical overview

		Output	Power supply	Load	Current consumption
Analogue	2 wire	4 ... 20 mA	10 ... 30 VDC	$< \frac{\text{power supply} - 10 \text{ V}}{0.02 \text{ A}}$ [Ohm]	< 23 mA
	3 wire	ration. 10 ... 90%	5 VDC ±10%	> 10 kOhm / < 100 nF	< 3 mA
	4 wire	ration. 10 ... 90%	5 VDC ±10%	> 10 kOhm / < 100 nF	< 3 mA
	(with temperature) Temperature	acc. page 5	5 VDC ±10%	> 1 MOhm / < 100 nF	< 3 mA
Digital ²⁾	3 wire	Pressure	3000 ... 11000 Digits	5 VDC ±10%	< 3 mA
(one wire interface)	(with temperature) Temperature	acc. page 5	5 VDC ±10%		< 3 mA
Polarity reversal protection	Short circuit proof and protected against polarity reversal.				

Dynamic response

Response time	< 2 ms
---------------	--------

Protection standard

IP 68	Protection class III
-------	----------------------

Runtime

Time starts at the moment of application of minimal supply voltage	< 10 ms
--	---------

Electrical connection

Cable PE-HD	2 ... 175 m
-------------	-------------

Test / Admissions

Electromagnetic compatibility	CE-conform acc. to EN 61326-2-3 KTW guidance
Drinking water verification certificate for plastic parts	DVGW process sheet W270 WRAS
Drinking water approval	ACS
EAC	
UL	ANSI/UL 61010-1 acc. E325110
Shock acc. IEC 68-2-27	25 g, 6 ms, half sine wave, all 3 directions
Vibration nach IEC 68-2-6	1 g, 2 ... 2000 Hz with amplitude ±15 mm, 1 Octave/min. all 3 directions

Weight

Without cable	~ 120 g
---------------	---------

Packaging

Single packaging
Multiple packaging

Accuracy

Parameter		Unit	
Max. deviation at 25 °C ³⁾		% fs	± 0.6
Resolution		% fs	0.1
Thermal characteristic ⁴⁾		% fs/10K	± 0.1
Long term stability acc. IEC EN 60770-1	max.	% fs	± 0.25

¹⁾ non-congealing media
⁴⁾ at 0 ... +80 °C

²⁾ Application note one wire digital out

³⁾ incl. zero point, full scale, linearity, hysteresis and repeatability

				1	2	3	4	5	6	7	8	9	10	11		
Order code selection table				713. X X X X X X X X X X X X												
Pressure range ¹⁾ (relative)	0 ... 0.6 bar	overload 4.8 bar		9	1	0										
	0 ... 1.0 bar	4.8 bar		9	1	1										
	0 ... 1.6 bar	4.8 bar		9	1	2										
	0 ... 2.5 bar	7.5 bar		9	1	4										
	0 ... 4.0 bar	12.0 bar		9	1	5										
	0 ... 6.0 bar	18.0 bar		9	1	7										
	0 ... 10.0 bar	20.0 bar		9	3	0										
	0 ... 16.0 bar	20.0 bar		9	3	1										
Pressure range ¹⁾ (absolute)	0.8 ... 1.4 bar	4.8 bar		8	1	1										
	0.8 ... 2.0 bar	6.0 bar		8	1	2										
	0.8 ... 3.0 bar	9.0 bar		8	1	4										
Sealing material	FPM	Fluoro-elastomer							0							
	EPDM	Ethylene propylene (for drinking water)							1							
Outout / power supply	4 ... 20 mA	10 ... 30 VDC	2 wire (with housing connection)							0						
	ration. 10 ... 90%	5 VDC ±10%	3 wire							1						
	ration. 10 ... 90%	5 VDC ±10%	4 wire (with temperature)							2						
	3000 ... 11000 Digits	5 VDC ±10%	3 wire (one wire interface, with temperature)							3						
Electrical connection ²⁾	Cable	2 m								0	0	1	1			
		3 m								0	1	1	1			
		5 m									0	2	1	1		
		7 m									0	3	1	1		
		10 m									0	4	1	1		
		15 m									0	5	1	1		
		20 m									0	6	1	1		
		25 m									0	7	1	1		
		30 m									0	8	1	1		
		40 m									0	9	1	1		
		50 m									1	0	1	1		
		60 m									1	1	1	1		
		70 m									1	2	1	1		
		80 m									1	3	1	1		
		90 m									1	4	1	1		
		100 m									1	5	1	1		
125 m									1	6	1	1				
150 m									1	7	1	1				
175 m									1	8	1	1				
Admissions	without drinking water approval														0	
	with drinking water approval								1				1		1	
Pressure range variation (optional)	Indicate W and state range on order (e.g.: W0... + 2bar/OUT4...20mA)														W	

Dimensions in mm / Electrical connections

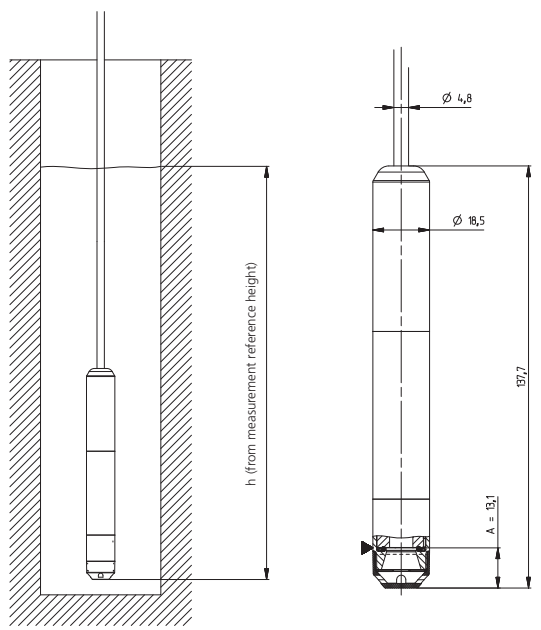

h - Fluid level
 ▶ - Measurement reference height
 A - Distance from protection cover to the position of measuring diaphragm

The electronic GND is connected with a 1MΩ resistor to the level transmitter housing.

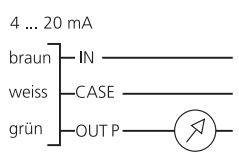
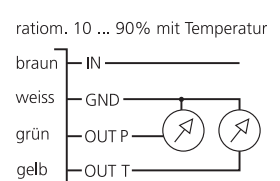
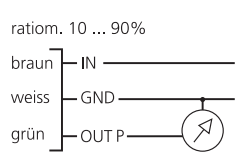
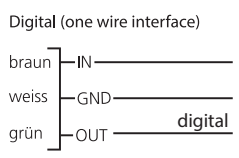

The case connection is connected with the level transmitter housing.

¹⁾ Other pressure range on request ²⁾ Other cable length on request

Accessories

Cable hanger	Bestellnummer
Connection box	118026
Humidity protection element (pack of 10)	118027
Calibration certificate	118068
	104551

Connection box

Cable hanger

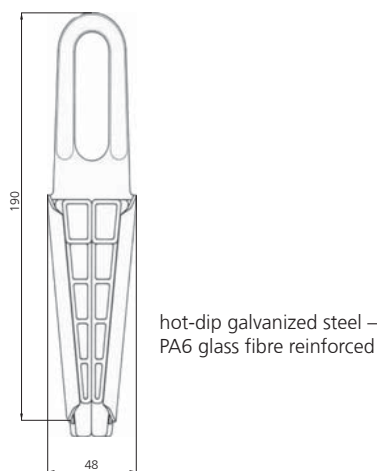
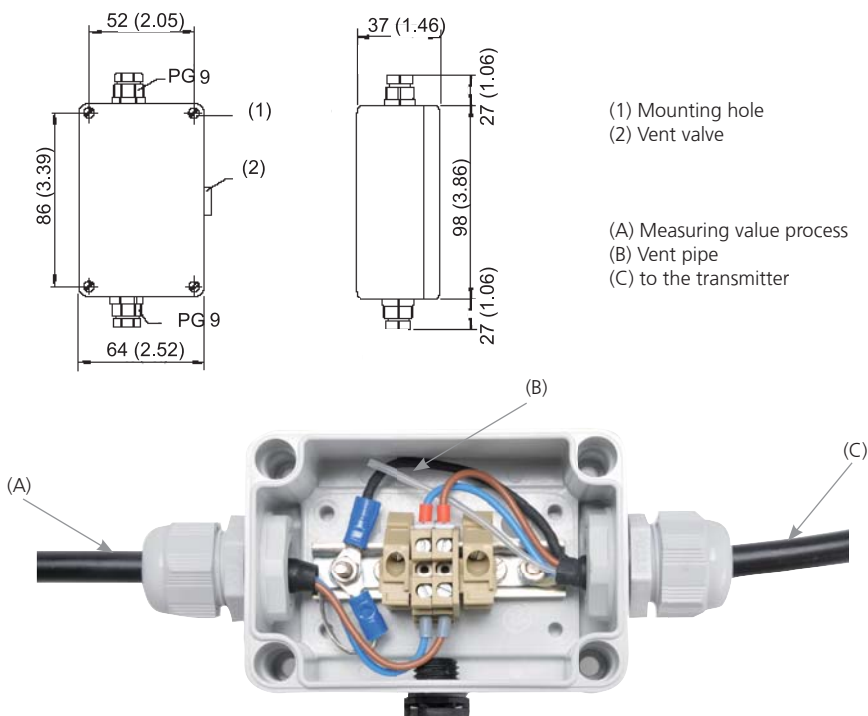

Cable Ø 4.5 ... 6.5

Calculation of level

General level with relative pressure sensor:

$$h = \frac{\Delta p}{\rho \cdot g}$$

General level with absolute pressure sensor:

$$h = \frac{P_{TS} - P_{Baro}}{\rho \cdot g}$$

which
$$P_{TS} = \frac{U_{TS} - U_{TS_NP}}{U_{TS_EW} - U_{TS_NP}} \cdot (P_{TS_EW} - P_{TS_NP}) + P_{TS_NP}$$

and
$$P_{Baro} = \frac{U_{Baro} - U_{Baro_NP}}{U_{Baro_EW} - U_{Baro_NP}} \cdot (P_{Baro_EW} - P_{Baro_NP}) + P_{Baro_NP}$$
 Using a second level sensor as barometric air pressure sensor

For level sensor with current output use nominal signal values for I_{TS} ... instead of variables U_{TS} ... (resp. I_{Baro} ... instead of U_{Baro} ...)

Simplification of formula for level sensor with ratiometric output:

$$P_{TS} = \frac{U_{TS} - 0.1 \cdot U_{IN}}{0.8 \cdot U_{IN}} \cdot (P_{TS_EW} - P_{TS_NP}) + P_{TS_NP}$$

$$P_{Baro} = \frac{U_{Baro} - 0.1 \cdot U_{IN}}{0.8 \cdot U_{IN}} \cdot (P_{Baro_EW} - P_{Baro_NP}) + P_{Baro_NP}$$
 Using a second level sensor as barometric air pressure sensor

Legend:

h	level [m]	ρ	density of media [kg/m ³]
		g	acceleration of fall 9.80665 [m/s ²]
Δp	measured relative pressure [Pa]	U_{TS}	signal on level sensor output [V or mA]
P_{TS}	measured pressure of level sensor [Pa]	U_{Baro}	Signal on barometer output [V or mA]
P_{Baro}	measured pressure of barometer [Pa]	U_{TS_NP}	minimal nominal signal of level sensor [V or mA]
P_{TS_NP}	minimal nominal pressure of level sensor [Pa]	U_{TS_EW}	maximum nominal signal of level sensor [V or mA]
P_{TS_EW}	maximum nominal pressure of level sensor [Pa]	U_{Baro_NP}	minimal nominal signal of barometer [V or mA]
P_{Baro_NP}	minimal nominal pressure of barometer [Pa]	U_{Baro_EW}	maximum nominal signal of barometer [V or mA]
P_{Baro_EW}	maximum nominal pressure of barometer [Pa]		

ration. 10 ... 90%

Digital

$$T_{TEMP} = T_0 + 1 \left/ \left(a + b \cdot \ln \left(R \cdot \left[\frac{U_{IN}}{OUT T} - 1 \right] \right) + c \cdot \ln \left(R \cdot \left[\frac{U_{IN}}{OUT T} - 1 \right] \right)^3 \right) \right.$$

$$T_{TEMP} = \left(\frac{T_{Dig}}{255} \cdot 200^\circ\text{C} \right) - 50^\circ\text{C}$$

T_{TEMP}	Sensor temperature [°C]	OUT T	sensor signal [V]
T_0	-273.15 [°C]	R	20'000 [Ω]
a	0.001204001	U_{IN}	power supply 5V ±10%
b	0.000208775		
c	0.000000294		

T_{TEMP}	Sensor temperature [°C]
T_{Dig}	digital value (0 ... 255 digits)
Max. error ±3 °C (bei 0 ... 80 °C)	

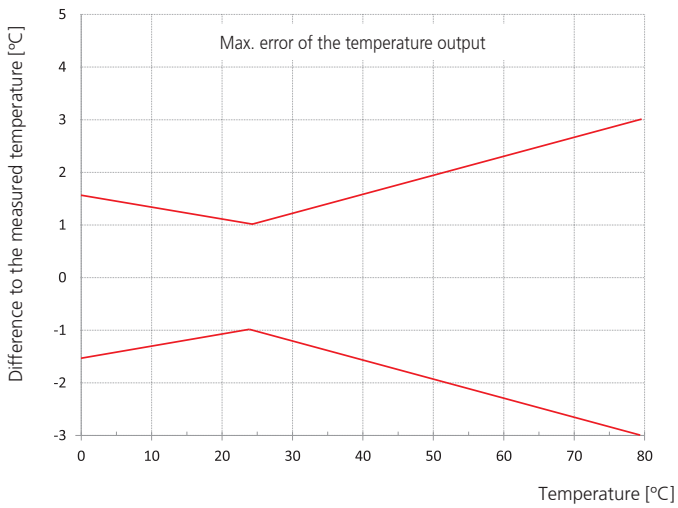
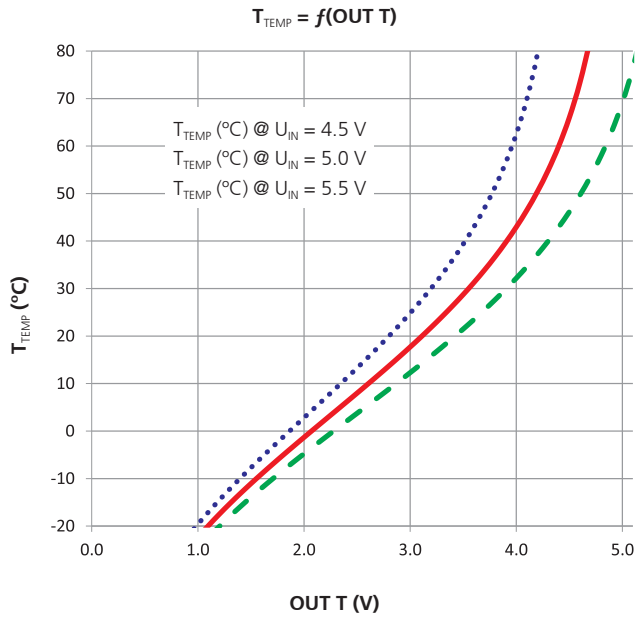

Huba Control AG

Headquarters

Industriestrasse 17
5436 Würenlos
Telefon +41 (0) 56 436 82 00
Telefax +41 (0) 56 436 82 82
info.ch@hubacontrol.com

Huba Control AG

Niederlassung Deutschland

Schlattgrabenstrasse 24
72141 Walddorfhäslach
Telefon +49 (0) 7127 23 93 00
Telefax +49 (0) 7127 23 93 20
info.de@hubacontrol.com

Huba Control SA

Succursale France

Rue Lavoisier
Technopôle Forbach-Sud
57602 Forbach Cedex
Téléphone +33 (0) 387 847 300
Télécopieur +33 (0) 387 847 301
info.fr@hubacontrol.com

Huba Control AG

Vestiging Nederland

Hamseweg 20A
3828 AD Hoogland
Telefoon +31 (0) 33 433 03 66
Telefax +31 (0) 33 433 03 77
info.nl@hubacontrol.com

Huba Control AG

Branch Office United Kingdom

Unit 13 Berkshire House
County Park Business Centre
Shrivenham Road
Swindon Wiltshire SN1 2NR
Phone +44 (0) 1993 776667
Fax +44 (0) 1993 776671
info.uk@hubacontrol.com